

Sollas packaging machinery is well-known worldwide for its excellent packaging quality. Continual innovation, together with the constant introduction of improved technology allows us to maintain the high standards demanded in the industry.

Because of their great flexibility, the Sollas overwrappers can be found in many different industries, such as perfumes/cosmetics, pharmaceuticals, stationery, cards, digital-media, tea/coffee, tobacco, confectionery and foods.

The Sollas SX-series is a revolutionary modular built automatic overwrapping machine. Servo drives provide full control over all machine motions and guarantee perfect product handling. Sollas uses servo systems from Siemens or Rockwell Automation.

The Sollas SX is extremely flexible and is easily adapted for a variety of products. Down times for a product change over are the shortest on the market for overwrapping machines. All adjustable units are provided with quick change devices.



SX60-HL with infeed at right angles from the left hand side

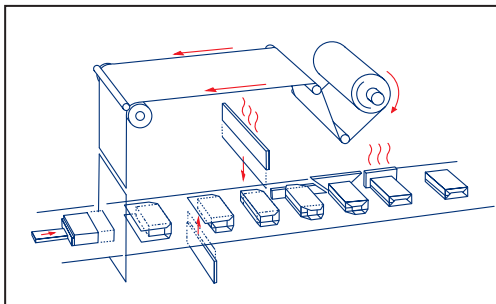

The overwrapping principle

In general, the machine was designed to require few product related change parts. The parts that are required, are easily exchanged and low priced. Sollas has made it a point that such parts should be produced with the shortest possible delivery time.

The Sollas SX60 can be provided with a folding section to handle products up to 96 mm or 125 mm high. The SX80 can handle products up to 66 mm high. Both models can also be provided with the revolutionary Universal Folding Section that requires no change parts.



Easy operation is always a key feature of Sollas machines. The Sollas SX is provided with a PLC and a highly intuitive touch-screen display. PLC and display can be from Siemens or Rockwell Automation.



SX80-DIL in special "Scratch Free" design for the perfumery industry

All Sollas machines can be equipped with a variety of infeed and outfeed systems (feeders, collators, turning, tilting). Integration is also possible with upstream and/or downstream equipment e.g. for case-packing, cartoning, stacking, banding and personalising.

Because of its straight forward design, maintenance of the Sollas SX, is extremely easy. As a rule, all spare parts are available from stock and can be shipped world wide at the first opportunity.

technical details						
all dimensions are in millimetres						
product size range	SX60			SX80		
	L	W	H	L	W	H
minimum standard	40	40	16	40	40	16
minimum adapted ¹⁾	-	20	7	-	20	7
maximum standard	300	225	96	300	175	66
maximum adapted ¹⁾	360	265	125	336	-	-
output ²⁾	60 strokes per minute			80 strokes per minute		
basic configuration	HL / HR / LL / DIL					
size change time ²⁾	5 - 15 minutes					
film width	50 - 435 mm					
film-roll diameter max.	400 mm					
packaging material ³⁾	PP or coated paper (20 micron and up)					
air consumption	5 ndm ³ / stroke (without accessories)					
working pressure	6 bar					
power consumption	4.0 kW (without accessories)					
machine weight (nett)	1000 kg approximately					
machine dimension	see sketch below					
machine colour	RAL 9010 (white)					
optional accessories	teartape applicator, printmark registration, film slitting, castors, various infeed systems, stainless steal cladding, perfect (spot) seal positioning by Individual Product Transport system (IPT), central lubrication, 2nd film-roll, splicing unit, felt linings, special colour, Universal Folding Section					
drive system	cam and servo					
control system	PLC (Siemens or Rockwell Automation)					

¹⁾ please be aware that certain modifications can result in restrictions in other dimensions or machine output

²⁾ depending on product, machine configuration and packaging material

³⁾ all materials are to be tested by Sollas before any commitment to the processability can be made

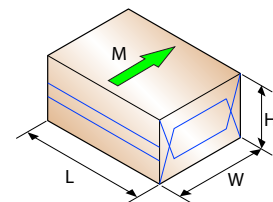

Product orientation.
M = direction through machine

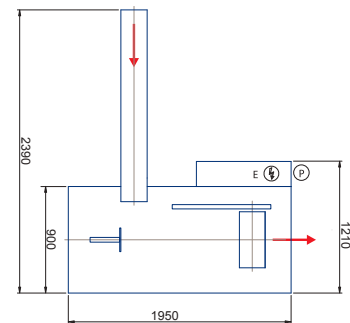

General dimensions of an HL configuration

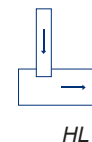

HL

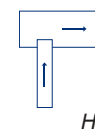

HR

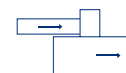

LL

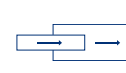

DIL